

# 规格书

## WWT230-05-90

### 6M 工业镜头

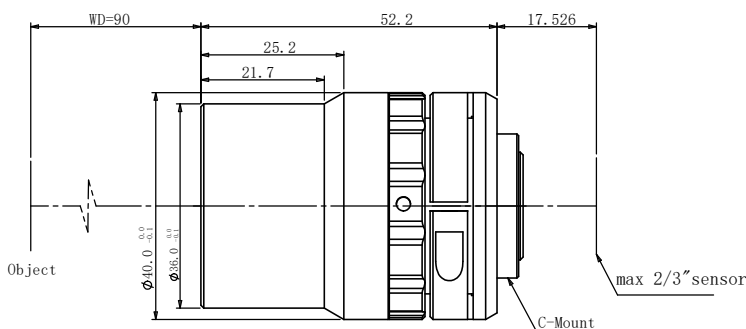

#### 光学参数

放大倍率 $\beta$ (x)	0.5
物方工作距 WD (mm)	90
支持 CCD 尺寸 ( $\Phi$ mm)	11.0(2/3")
像方 F/#	7.0
焦距 (mm)	38.01
数值孔径 NA	0.03574
物方分辨率 ( $\mu$ m)	9.4
物方景深 DoF (mm)	2.2
像方 MTF30 (lp/mm)	118
TV 畸变 (%)	-0.022

#### 视野范围 (mm × mm)

1/1.8" (7.13x5.37)	14.26x10.74
1/1.8" (7.43x4.9)	14.86x9.8
2/3" (8.45x7.1)	16.9x14.2

#### 机械参数

相机接口	C
镜头总长 (mm)	52.2
是否同轴光 / 可调光栏	否 / 否

